



CARDIOVASCULAR & THORACIC INSTRUMENTS

- **CARDIOVASCULAR FORCEPS**
- **RIB CONTRACTORS**
- **RIB SPREADERS**
- **RIB SHEARS & CHISELS**
- **VARICOSE VEIN SETS**





THORACIC/CARDIOVASCULAR

Thorax-cardiovasculaire
Thorax-cardiovasculaire

Torace-cardiovascolare
Torax-cardiovasculaire



GREGORY-SOFT



LG10-001-090
9 cm, 3 1/2"



LG10-002-110
11 cm, 4 1/2"



GREGORY-SOFT
11 cm, 4 1/2"



LG10-003-001
left



LG10-004-002
right



DEBAKEY

LG10-005-080
8 cm, 3 1/4"
Jaw 20 mm
Straight

LG10-006-090
9 cm, 3 1/2"
Jaw 30 mm
Straight



LG10-007-105
10.5 cm, 4"
Jaw 45 mm
Straight



LG10-008-125
12.5 cm, 5"
Jaw 68 mm
Straight



DEBAKEY

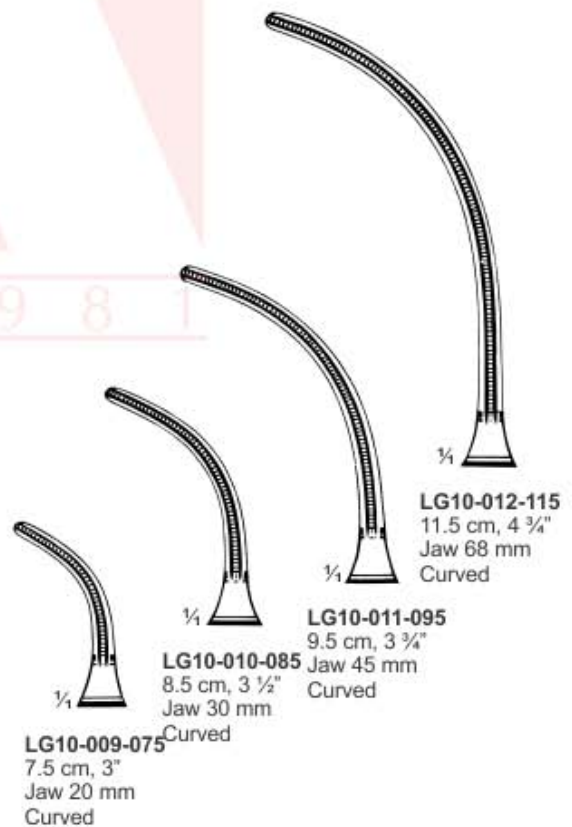

LG10-011-095
9.5 cm, 3 3/4"
Jaw 45 mm
Curved

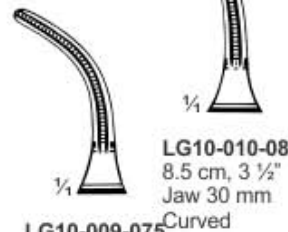

LG10-010-085
8.5 cm, 3 1/2"
Jaw 30 mm
Curved



LG10-009-075
7.5 cm, 3"
Jaw 20 mm
Curved

LG10-012-115
11.5 cm, 4 3/4"
Jaw 68 mm
Curved



THORACIC/CARDIOVASCULAR

Thorax-cardiovasculaire

Thorax-cardiovasculair

Torace-cardiovascolare

Torax-cardiovascular



DIEFFENBACH



LG10-013-038
3.8 cm, 1 1/2"



LG10-014-038
3.8 cm, 1 1/2"



LG10-015-051
5.1 cm, 2"



LG10-016-060
6 cm, 2 1/4"



LG10-017-060
6 cm, 2 1/2"



LG10-018-060
6 cm, 2 1/2"



DIETRICH



LG10-019-049
4.9 cm, 2"
Jaw 8 mm
Straight



LG10-020-053
5.3 cm, 2"
Jaw 12 mm
Straight



LG10-021-059
5.9 cm, 2 1/4"
Jaw 20 mm
Straight



LG10-022-043
4.3 cm, 1 3/4"
Jaw 8 mm
Curved



LG10-023-045
4.5 cm, 1 3/4"
Jaw 12 mm
Curved

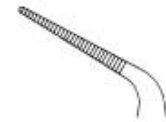

LG10-024-050
5 cm, 2"
Jaw 20 mm
Curved

S I N C E 1 9 8 1



BULLDOG CLAMP



LG10-025-043
4.3 cm, 1 3/4"
Jaw 13 mm
Curved



LG10-026-049
4.9 cm, 2"
Jaw 18 mm
Curved

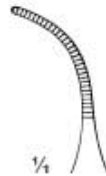

LG10-027-054
5.4 cm, 2 1/4"
Jaw 20 mm
Curved



THORACIC/CARDIOVASCULAR

Thorax-cardiovasculaire
Thorax-cardiovasculair

Torace-cardiovascolare
Torax-cardiovascular



MORRIS-DE BAKEY

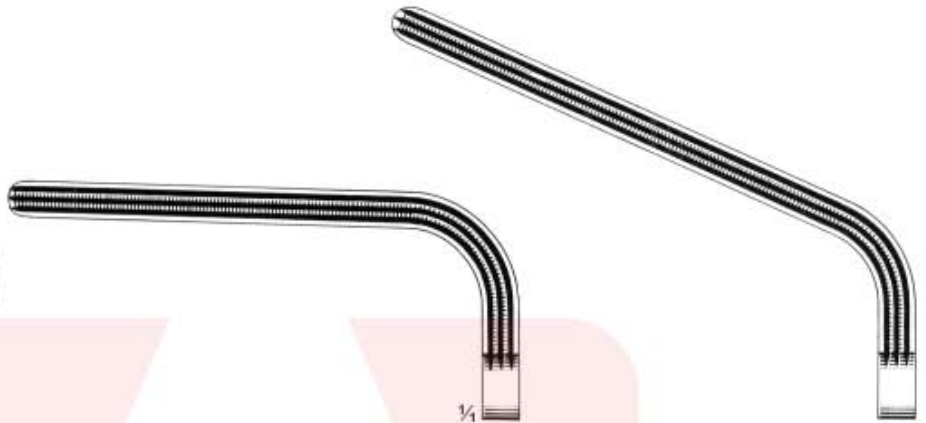

$\frac{1}{4}$
LG10-028-180
18 cm, 7"

LG10-029-200
20 cm, 8"



LG10-030-230
23 cm, 9"

LG10-031-250
25 cm, 10"

SINCE 1981



THORACIC/CARDIOVASCULAR

Thorax-cardiovasculaire
Thorax-cardiovasculair

Torace-cardiovascolare
Torax-cardiovascular



DE BAKEY

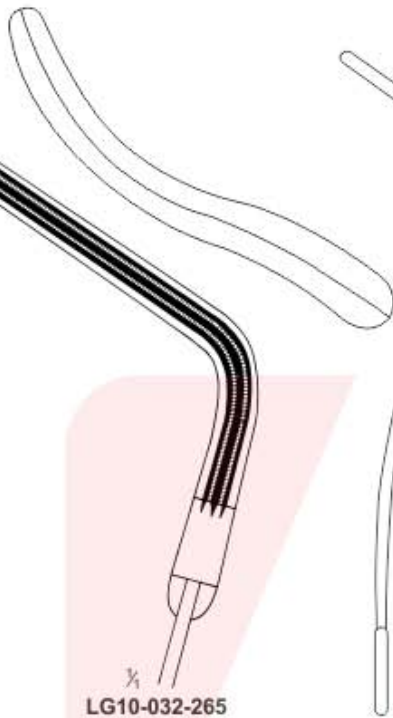

LG10-032-265
26.5 cm, 10 1/2"

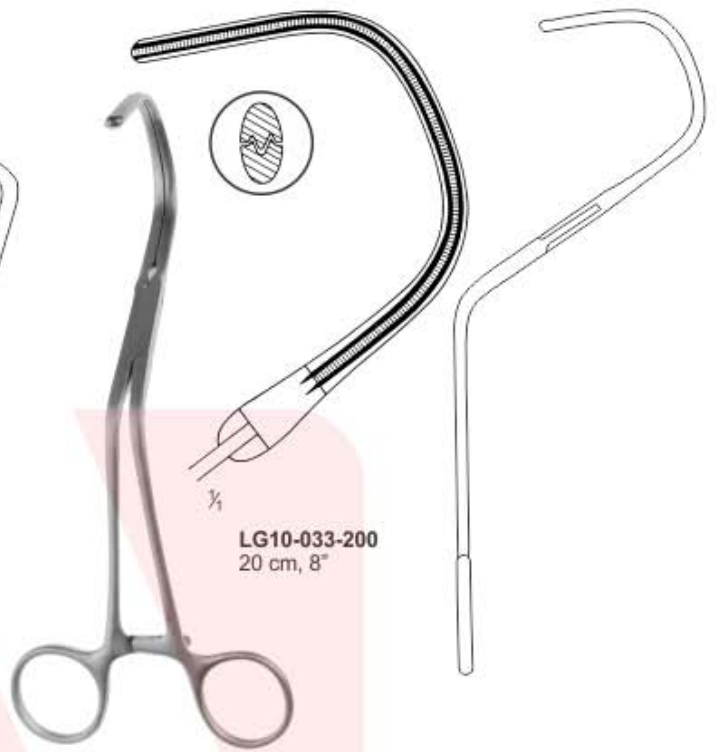

LG10-033-200
20 cm, 8"

KAY



DE BAKEY
Right Angled Jaws



LG10-034-190
19 cm, 7 1/2"



LG10-035-200
20 cm, 8"

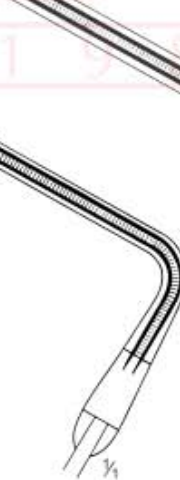

LG10-036-220
22 cm, 8 3/4"



LG10-037-270
27 cm, 10 3/4"





THORACIC/CARDIOVASCULAR

Thorax-cardiovasculaire

Thorax-cardiovasculair

Torace-cardiovascolare

Torax-cardiovascular

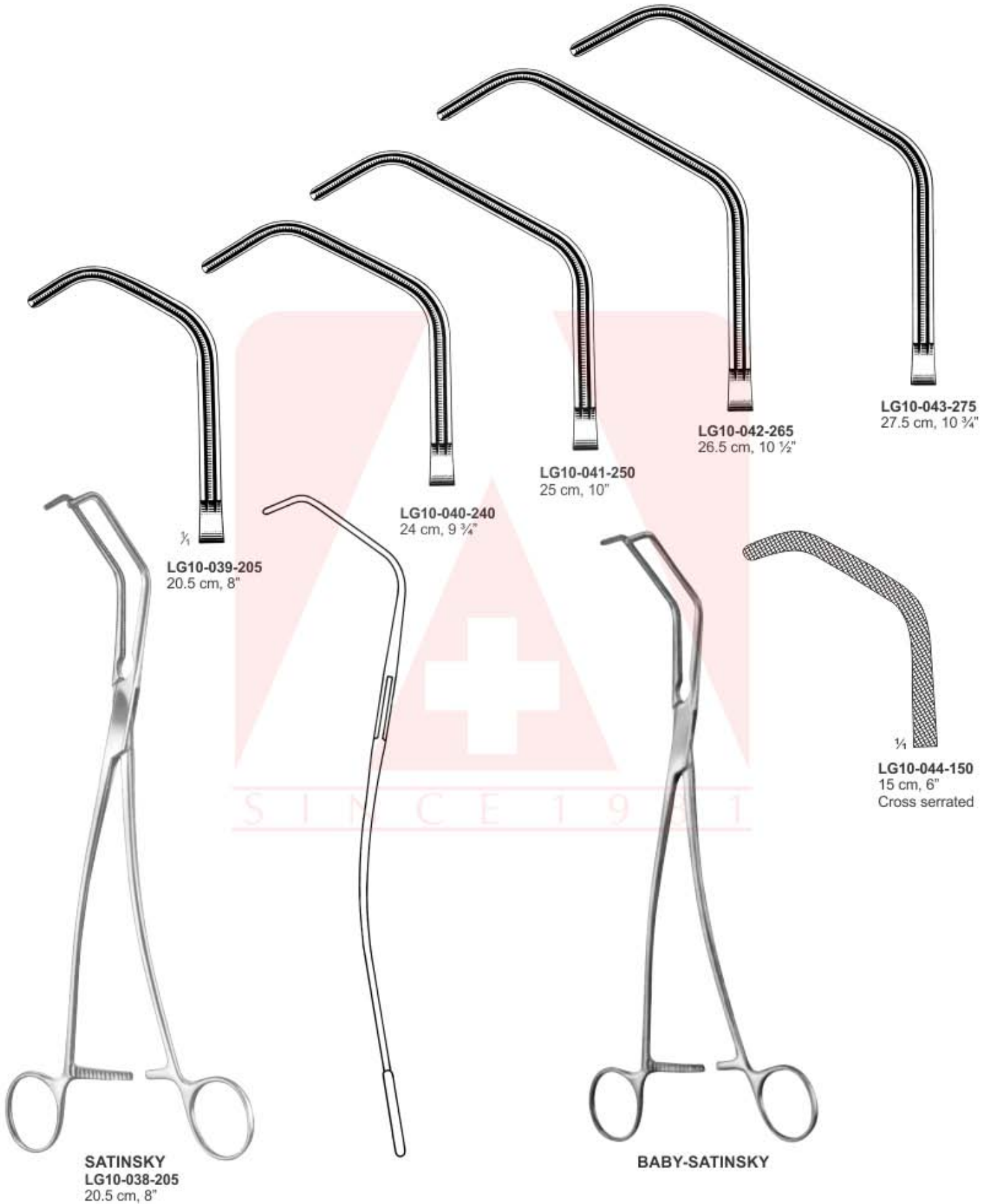



RIB CONTRACTORS

Rippenkontraktoren
Aproximadores para costillas

Rapprocheurs des côtes
Approssimatori costali



BAILEY-GIBBON
LG10-045-200
20 cm, 8"
For Adult



LG10-046-200
20 cm, 8"
For children



BAILEY-BABY
LG10-047-150
15 cm, 6"



SELLORS RIB CONTRACTOR
LG10-048-200
20 cm, 8"



BLALOCK



LG10-049-150
15 cm, 6"



LG10-050-200
20 cm, 8"



LG10-051-200
20 cm, 8"



LUNG SPATULAS, AORTIC DILATORS

Lungenspatel, Aorta-Dilatatoren
Espátulas pulmonares, Dilatadores aórticos

Spatules pulmonaires, Dilatateurs pour aorte
Spatole per pulmone, Dilatatori per aorta

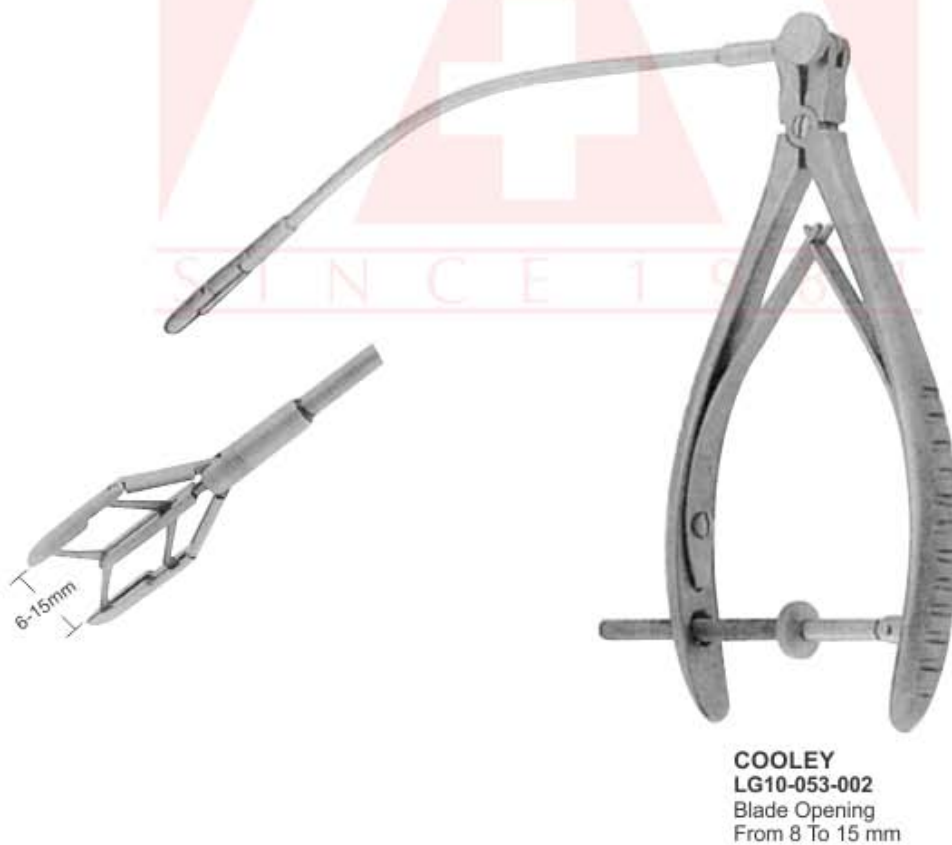
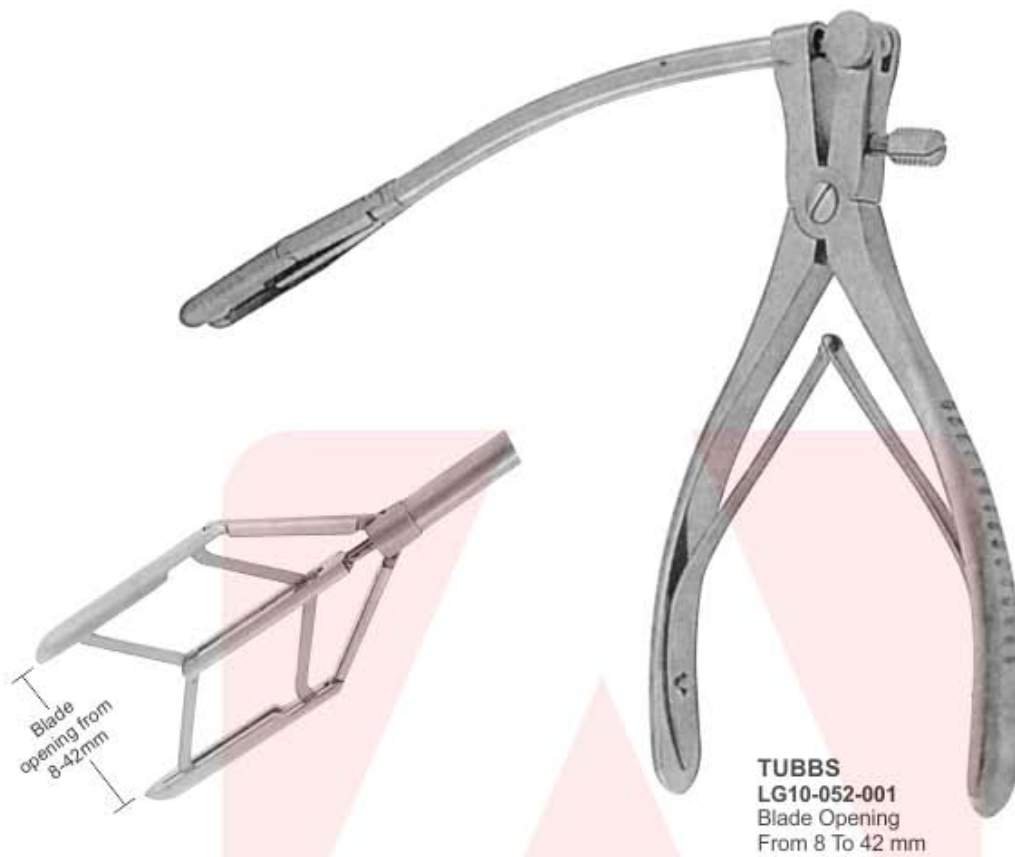



RIB RETRACTORS

Rippensperrer
Separador costal

Ecarteur de côtes
Divaricatore costale



COOLEY
LG10-054-001
lateral blades 12 x 16 mm
spreading 95 mm

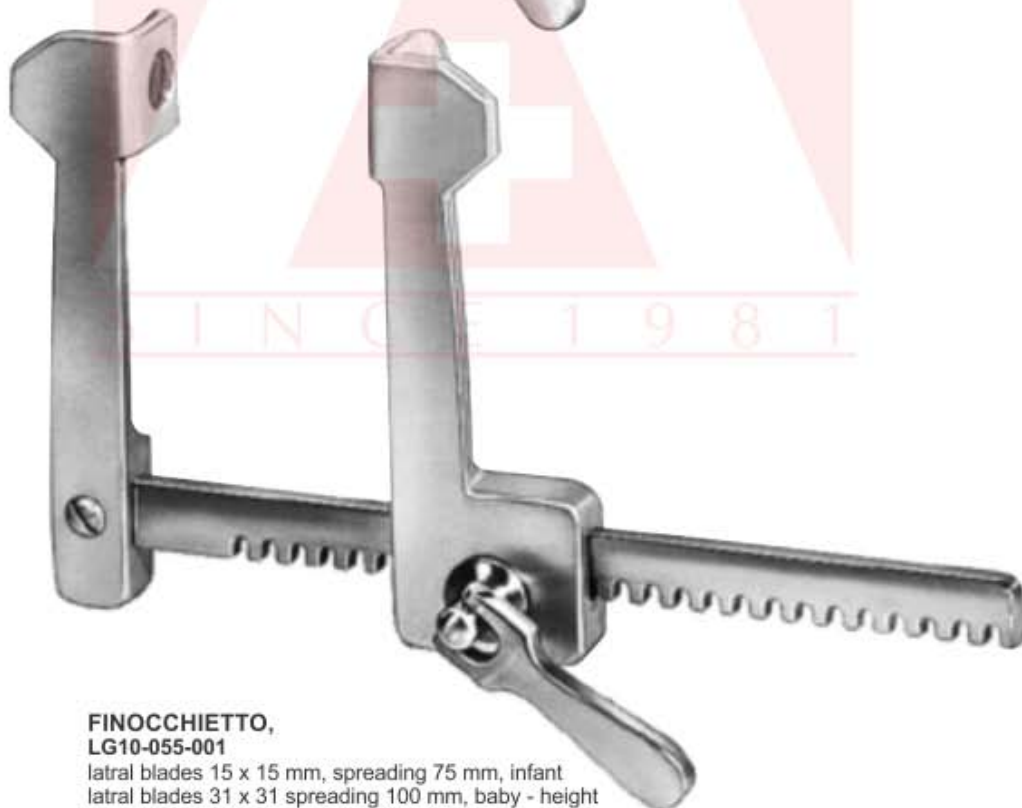

FINOCCHIETTO,
LG10-055-001
lateral blades 15 x 15 mm, spreading 75 mm, infant
lateral blades 31 x 31 spreading 100 mm, baby - height
lateral blades 40 x 45 spreading 135 mm, baby - height
lateral blades 52 x 62 spreading 175 mm, baby - height
lateral blades 84 x 65 spreading 175 mm, baby - height



RIB RETRACTORS

Rippensperrer
Separador costal

Ecarteur de côtes
Divaricatore costale



HAIGHT RIB RETRACTOR
LG10-056-001
lateral blades 30 x 30 mm, spreading 120 mm



MORSE-FAVALORO STERNAL RETRACTOR
LG10-057-001
4 movable blades 17 x 22 mm, spreading 160mm for children



FINOCCHIETTO (MODIF.)
LG10-058-001
lateral blades 14 x 15 mm, spreading 120 mm

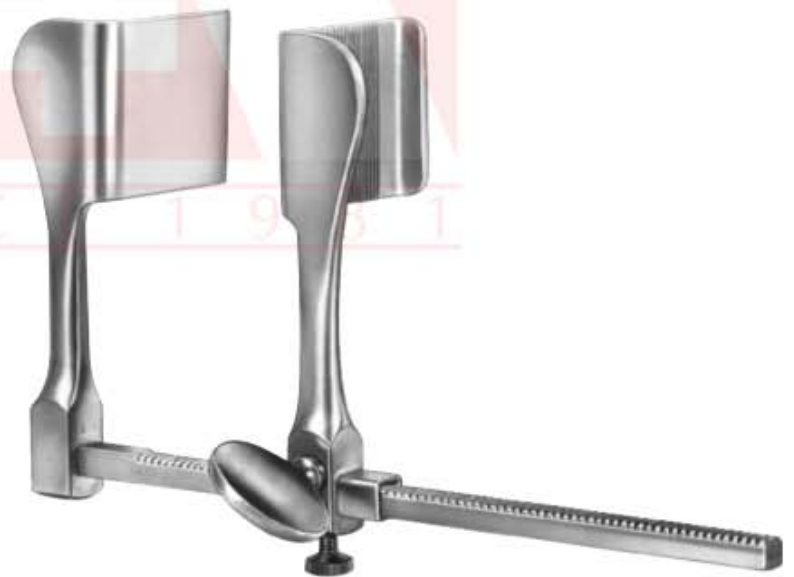

TUFFIER RIB RETRACTOR
LG10-059-001
lateral blades 45 x 45 mm, spreading 160 mm



RIB RETRACTORS

Rippensperrer
Separador costal

Ecarteur de côtes
Divaricatore costale

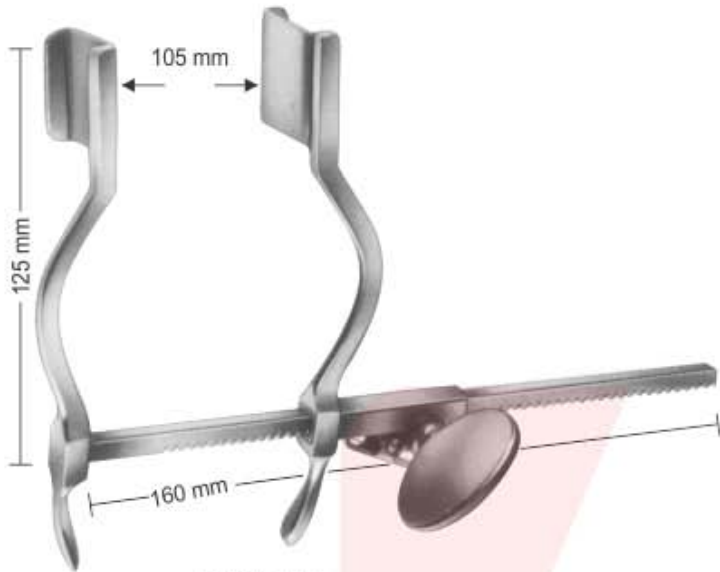

HERTZLER
LG10-060-001
blades 20 x 25 mm, spreading 105 mm

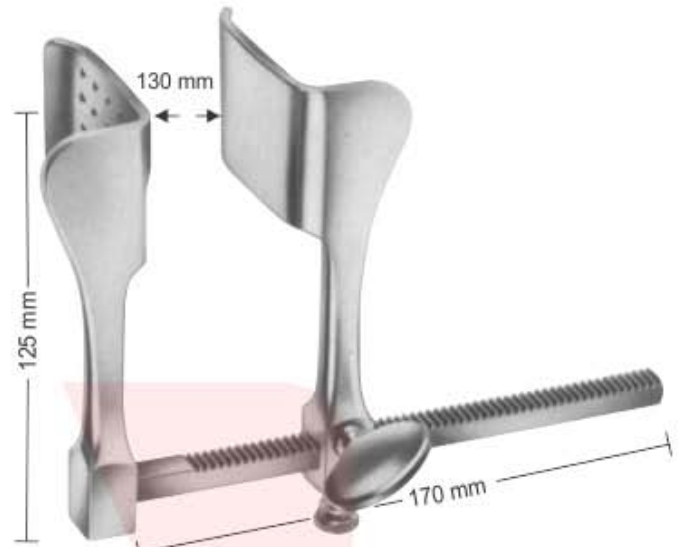

TUFFIER
LG10-061-001
blades 43 x 53 mm, spreading 130 mm



THORACIC RETRACTOR
LG10-062-001 Retractor only
LG10-063-002 1 pair of blades, 48 x 68 mm
LG10-064-003 1 pair of blades, 70 x 75 mm



$\frac{1}{4}$
LG10-063-002
48 x 68 mm
pair



$\frac{1}{4}$
LG10-064-003
70 x 75 mm
pair



THORACIC & I.M.A
LG10-065-001 Complete set
LG10-066-002 Lateral blades for I.M.A Retractor
Left 40 x 50 x 80 mm
LG10-067-003 Lateral blades for I.M.A Retractor
Right 40 x 50 x 80 mm



RIB SHEARS, STERNUM CHISEL

Rippenscheren, Sternummeißel
Costotomos, Cinceles

Costotomes, ciseau-Burin à sternum
Costotomi, Scalpello per sterno



SAUERBRUCH-FREY
LG10-068-370
for the first rib
37 cm, 14 1/2"



SCHUMACHER
LG10-069-210
sternum shears
21 cm, 8 1/4"



BONE SHEAR
LG10-070-230
23 cm, 9"



RIB SHEAR
LG10-071-230
23 cm, 9"



GLUCK
RIB SHEAR
LG10-072-220
22 cm, 8 3/4"



LEBSCHKE
STERNUM CHISEL
LG10-073-245
24.5 cm, 9 3/4"





RIB SHEARS, STERNUM CHISEL

Rippenscheren, Sternummeißel
Costotomos, Cinceles

Costotomes, ciseau-Burin à sternum
Costotomi, Scalpello per sterno



SAUERBRUCH
LG10-074-240 24 cm, 9 1/2" For Children,
LG10-075-270 27 cm, 10 3/4" For Adults,

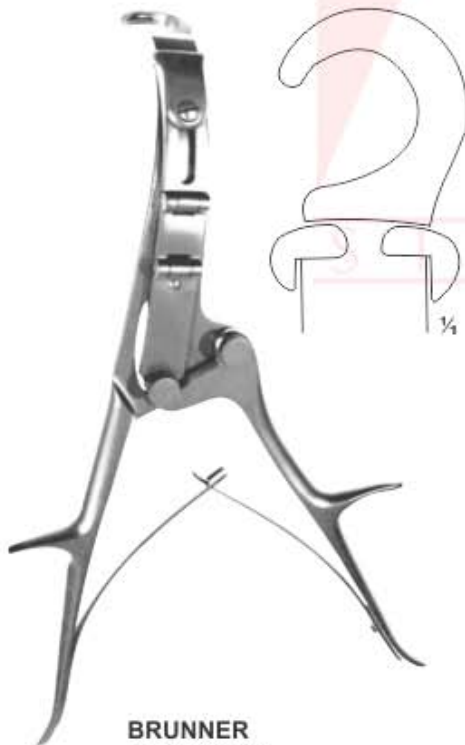

BRUNNER
LG10-076-335
33.5 cm, 13"

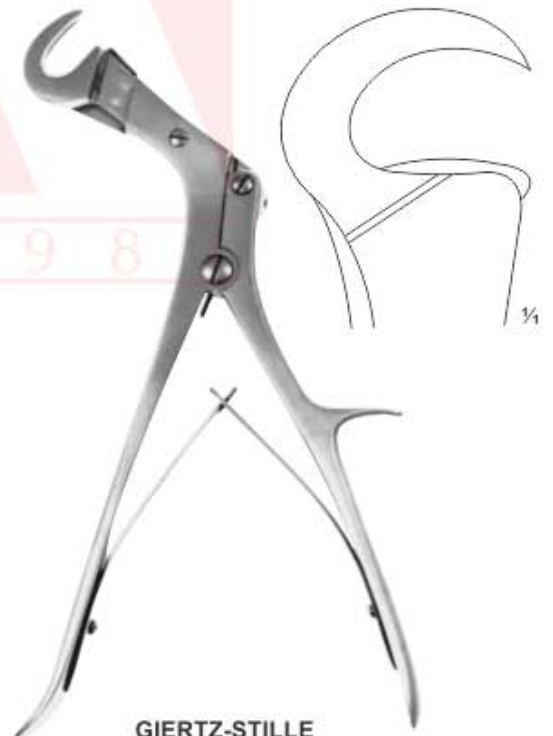

GIERTZ-STILLE
LG10-077-270
27 cm, 10 1/2"



THORACIC/CARDIOVASCULAR

Thorax-cardiovasculaire

Thorax-cardiovasculair

Torace-cardiovascolare

Torax-cardiovascular

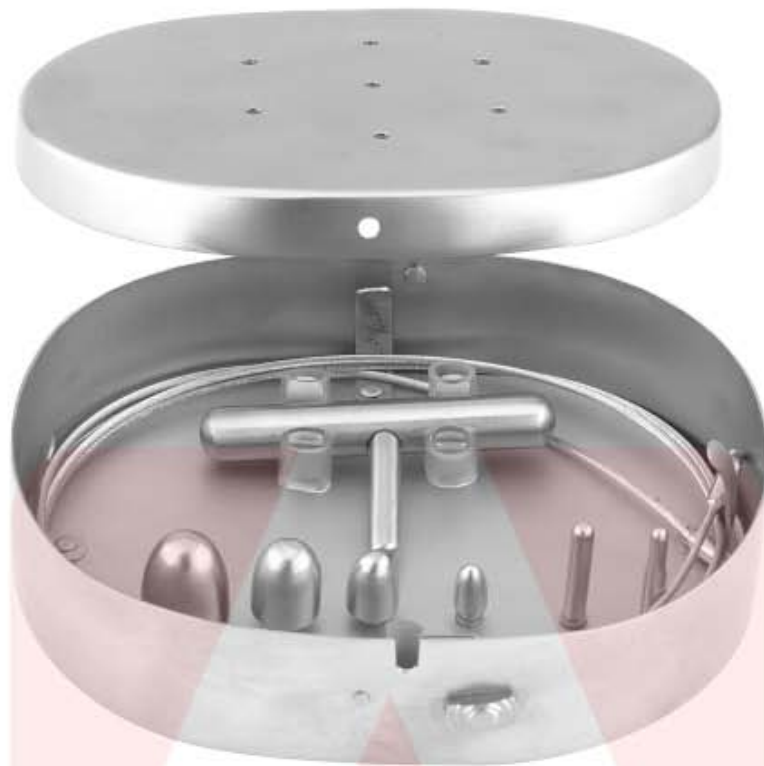

NABATOFF
LG10-078-001
varicose vein probe
set complete



LG10-079-002
Plastic Probe tip



LG10-080-003
3 mm Ø
Olive



LG10-081-004
6 mm Ø
Olive



LG10-082-005
9 mm Ø
Olive

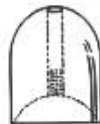

LG10-083-006
12 mm Ø
Olive

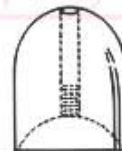

LG10-084-007
15 mm Ø
Olive

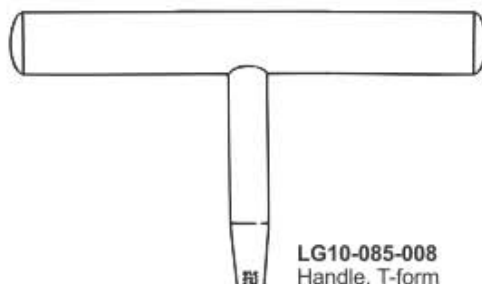

LG10-085-008
Handle, T-form



TRACTION CABLE
LG10-086-900
90 cm, 36"